





ANNEX 2 Installation document for alcohol interlocks

Product
Supplier: Alcohol Countermeasure Systems Corporation
Model: V3

1. Product Introduction

Table 1.1

No	Part Name and Description	Picture
1	V3 ECU (24 volt)	
2	V3 handset	
3	Handset clip fixture	
4	ECU to interlock handset cable	

5	ECU wiring harness	
6	Round mouthpieces (bag of 25) (95-000250)	

2. Product end connectors and vehicle end connectors pin definition

(1) Projection diagram of product end connectors: (ECU end harness)

BYD mating connector in accordance with the relevant requirements of the supplier of alcohol locks

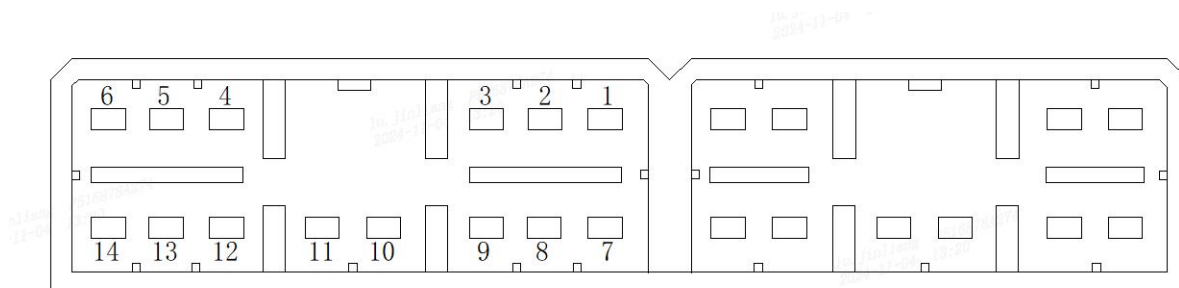

(2) Projection diagram of wire harness end connectors: (Distribution box end harness on vehicle, connect with ECU end connectors)

BYD mating connector in accordance with the relevant requirements of the supplier of alcohol locks

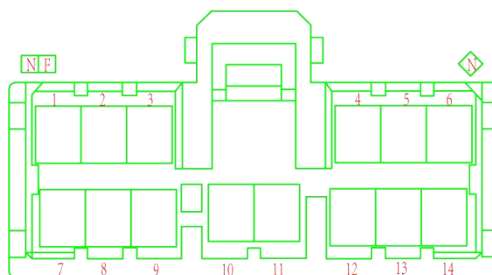



(3) Pin Definition
Table 2.1

Pin	ECU wiring harness color (Alcohol lock ECU comes with harness)	Product end harness color (BYD mating connector)	Port definition	Connection end (vehicle end connectors)	Connection end color	Steady state operating current	Power supply	Remark
1	Red	Red	24 volts, fused 10A	Distribution box	Red	7A	Constant electricity	Input 24V
2	Green	Green	Vehicle operation signal	Distribution box	Green	7A	ON position	Input 24V
3	/	/	/	/	/	/	/	/
4	/	/	/	/	/	/	/	/
5	Blue/Yellow	Gray	From ignition switch	Distribution box	Gray	7A	ON position	Input 24V
6	Blue	Blue	To starter	IBCM	Blue	/	/	/
7	Black	Black	Ground	Ground	Black	/	/	Ground
8	White	White	Electric start switch	Distribution box	White	7A	ON position	Input 24V
9	/	/	/	/	/	/	/	/
10	/	/	/	/	/	/	/	/
11	/	/	/	/	/	/	/	/
12	/	/	/	/	/	/	/	/

(4) System principle

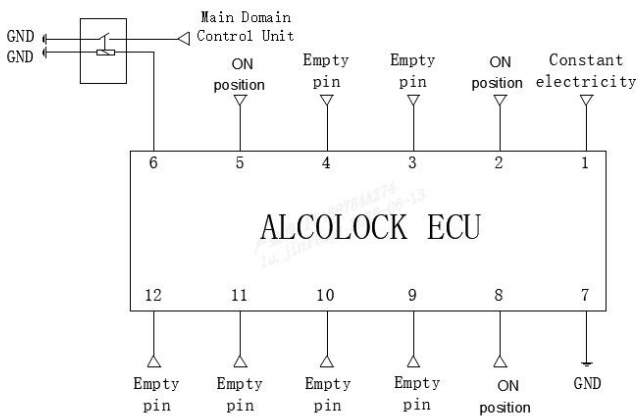

The detailed guide pin definition is shown in the table.
The 3/4/9/10/11/12 pins are empty pins, represents no need to connect with any product.

3. Product installation

The handset is installed in a place that the driver can reach and is not affected by other components of the vehicle, and is usually installed on the A pillar.

The handset is connected to the ECU by the product's built-in harness.

The handset is installed on the Handset clip fixture, AS shown in the figure.

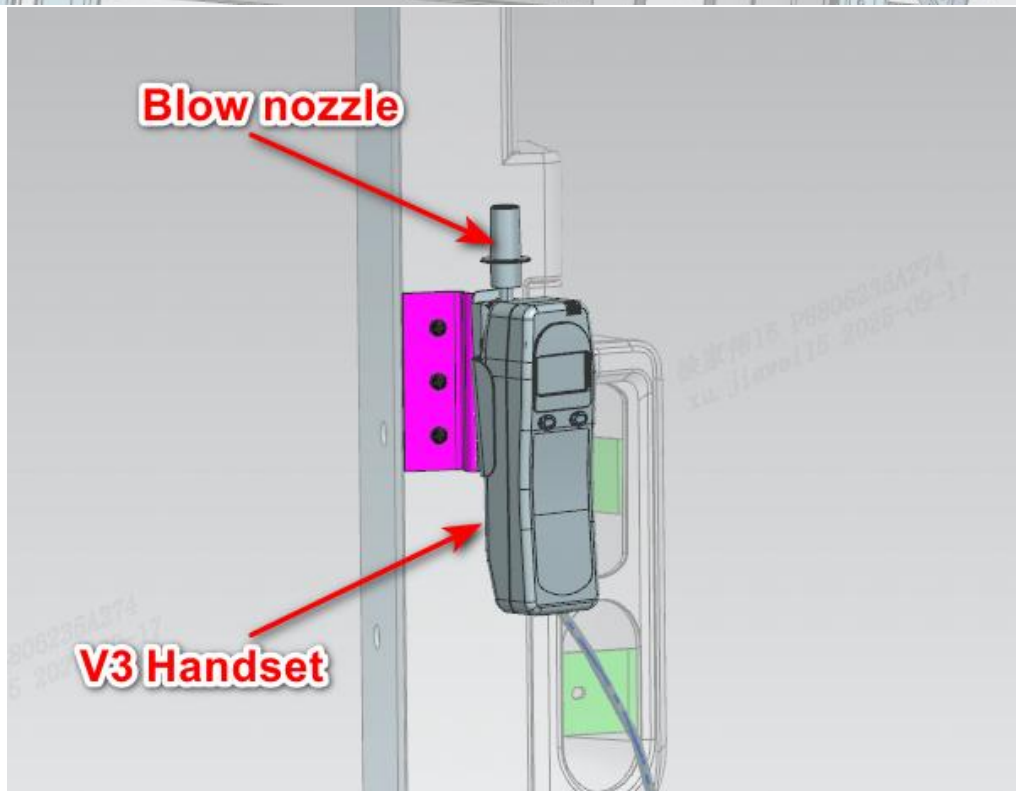
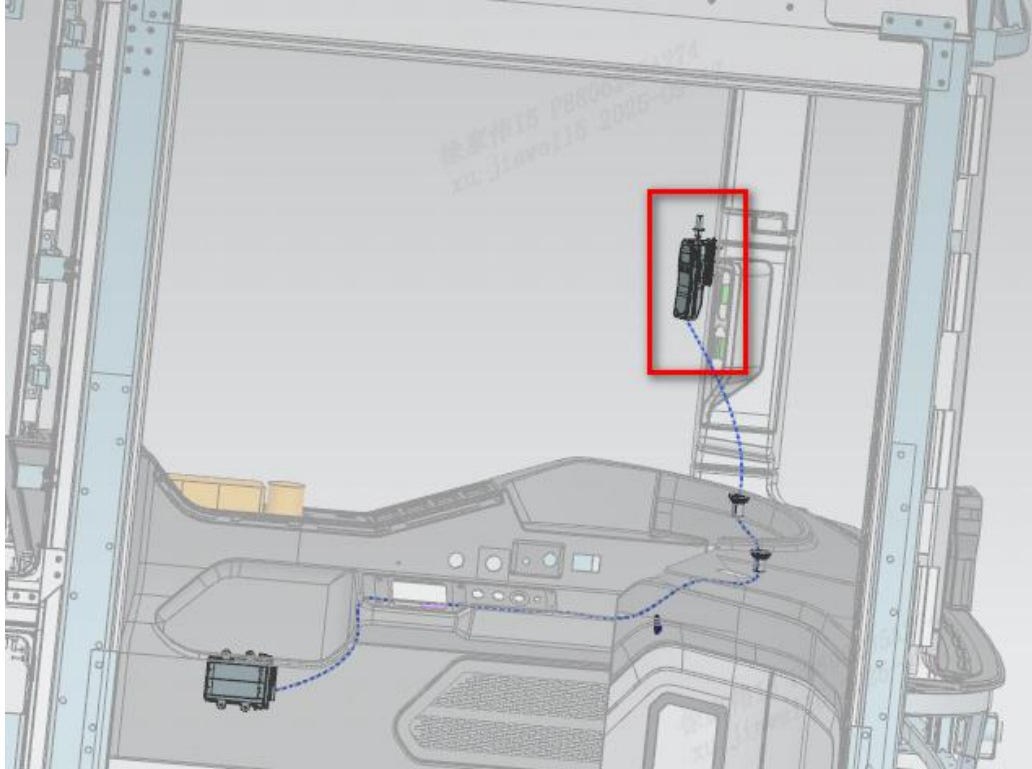

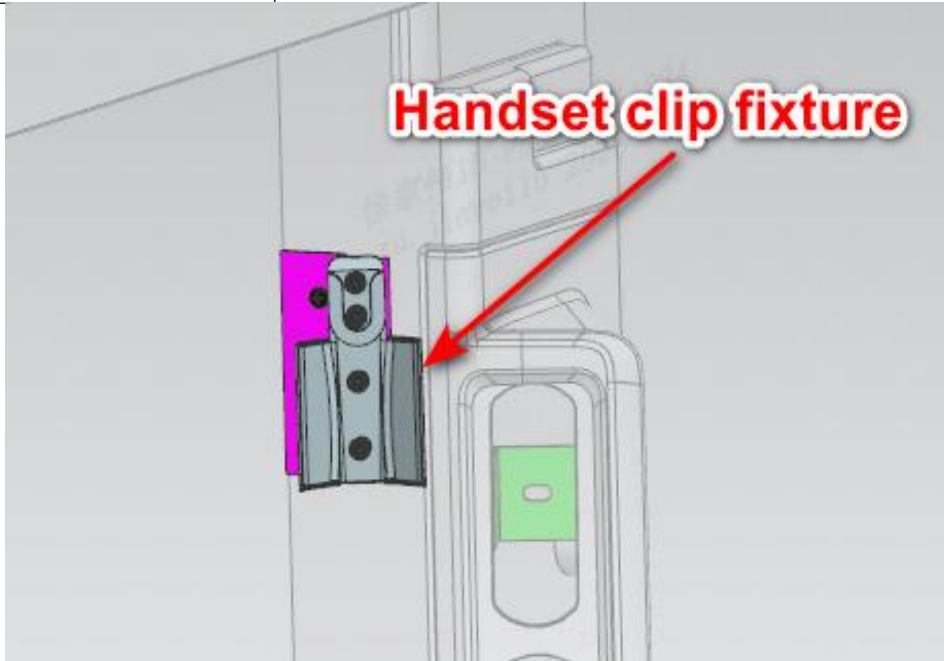

The ECU is concealed and installed below the instrument panel. The ECU harness is connected to the vehicle harness.

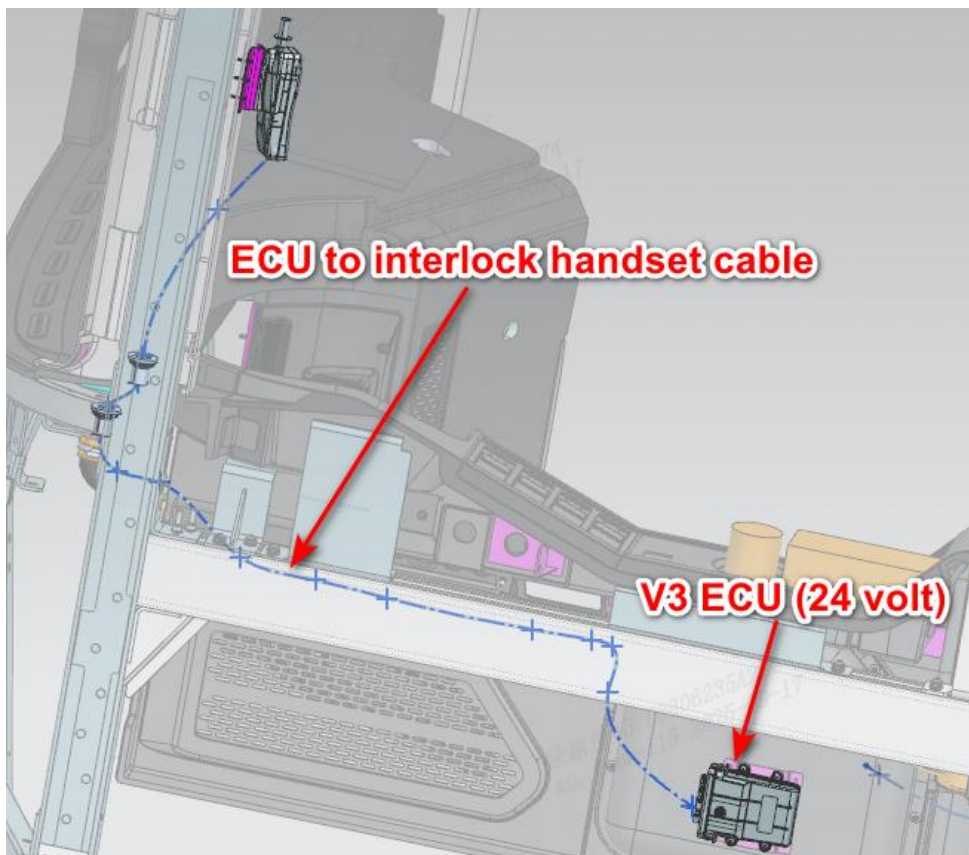

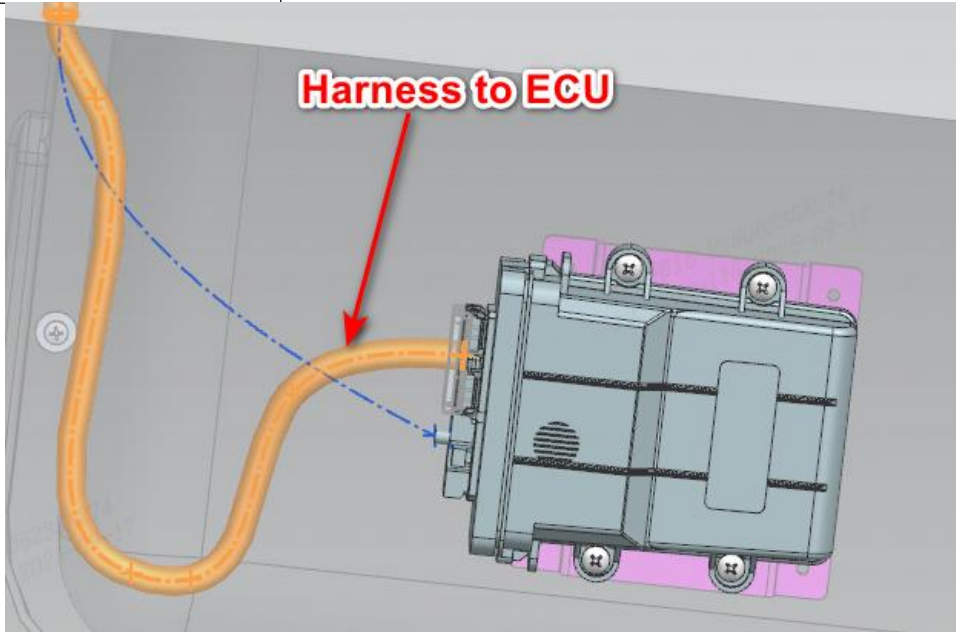

Low Voltage Distribution Box Lead-in Harness Connector (reserved on vehicle) is placed under the sleeper, detailed on the rear side of the Alcohol Locking ECU, visible when opening the sleeper.



4. Product function

Before starting a vehicle equipped with the alcohol lock device, the driver must undergo an alcohol test. The vehicle can only be started when the measured alcohol concentration is below the set limit value. (Attention: The device is not a safety device and cannot replace the anti-theft locking device)
The alcohol lock device only interferes with vehicle movement before the vehicle starts and does not affect the vehicle in motion.

5. Product working principle

Alcohol locks is prohibited from shifting gears. Only after the alcohol blowing test and the alcohol lock output high level gives IBCM, IBCM to collect high level signals and sends "the alcohol content normal state", the vehicle can be allowed to start, in other cases the alcohol lock does not output the high level, which is kept by IBCM to send "alcohol content state - excessive or unenabled" message, so that the vehicle can not be able to drive.

EN 50436-7:2016 Annex C 3B: Pseudo-digital installation.

6. Functional testing process

Table 6.1

No	Operation Steps	Implementation Results
1	<p>Before the first test after installation, turn OFF the gear and enter the activation code: 2132 on the handheld.</p> <p>The 2132 is an activation code for the first time the device is used and does not need to be entered the next time it is used.</p>	Activate alcohol lock



2	OFF position, turn on the power of the handset by pressing the right button, and observe the handset page display.	Display wait messages during warm up.
3	OFF position, when ready for breath test, watch the handheld page display. Note: Do not store the mouthpiece in a cold area. This will cause condensation in the mouthpiece and increase moisture into the handset.	The page shows & quote: Blow for 5 seconds. to indicate that you can start to blow, and remind you to blow for 5 seconds.
4	OFF position, insert mouthpiece. Blow into the mouthpiece continuously and moderately for more than 5 seconds, while listening to the sound of expiratory flow and observing the display on the handheld page.	4.1 When you hear a "click" sound and the page displays "Start engine", it means that the blowing is successful; you can start the engine. Note: The engine must be started within 5 minutes. 4.2 The page displays "Blow longer and harder" indicating that the attempted blowing does not meet the requirements, reminding the need to blow longer and harder. 4.3 The page shows "Caution" which means that the breath test was passed but the alcohol detected was below the limit. There are 2 options: 4.3.1 If you are sure there is no alcohol on your breath, wait 5 minutes and then try the test again. 4.3.2 Pressing the right (start) button directly confirms that you will be driving with alcohol in your system. Note: Must be started within 5 minutes.
5	OFF position, if no alcohol lock blow test is performed, or if the blow test is failed.	Vehicle will not start
6	After blowing successfully, the vehicle starts high voltage: When the driver disconnects the high voltage or negative switch for no more than 30 minutes.	The page shows "Restart available": This means that the vehicle can be powered up without having to repeat the breath test and can be driven.

7. Installation steps

Table 7.1

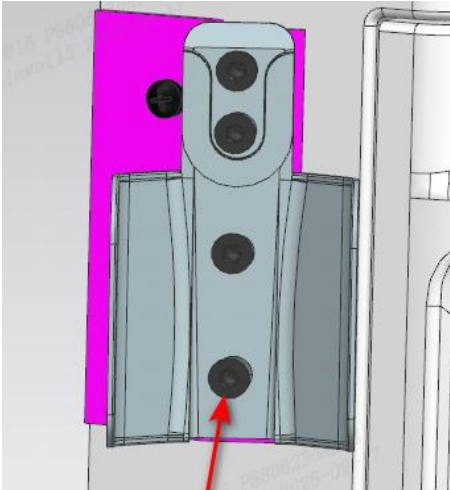
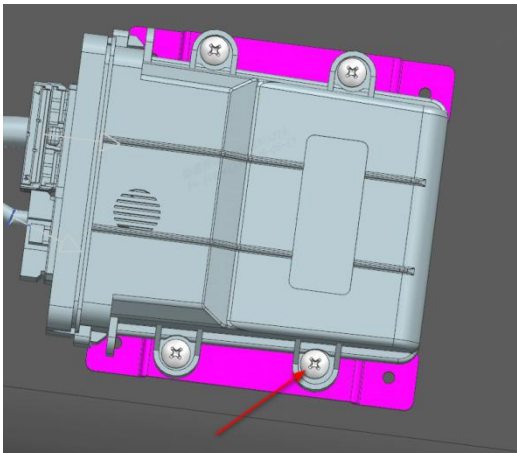
No	Products	Installation Location/Photo	Fasteners	Number of fasteners
1	Alcohol Lock Parts	 <p data-bbox="523 936 635 967">Figure 7.1</p> <p data-bbox="352 996 995 1057">1.1 Secure the Handset clip fixture to the interior panel with 4 pieces open end countersunk head blind rivets.</p>	Open end countersunk head blind rivet	4
		 <p data-bbox="550 1541 662 1572">Figure 7.2</p> <p data-bbox="352 1601 995 1662">1.2 Fix the alcohol lock ECU on the bracket with 4 cross recessed pan head self-tapping screws.</p>	Cross recessed pan head tapping screw	4

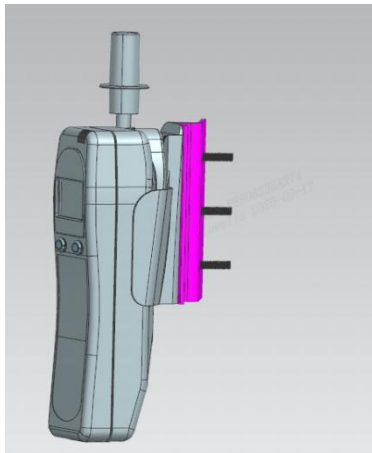

Figure 7.3

1.3 Attach the handset to the Handset clip fixture.

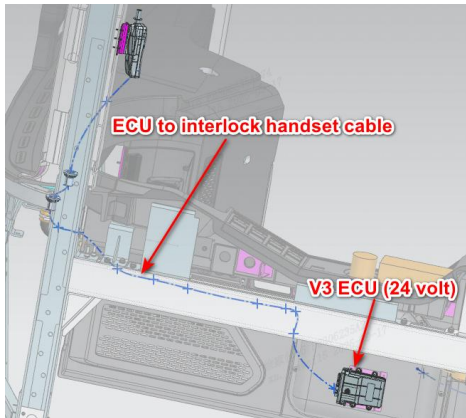

Figure 7.4

2.1 The approximate location of the Alcohol Lock ECU harness is shown in the figure, and it is fixed along the instrument panel wiring harness by tie-wrap and sponge tape.

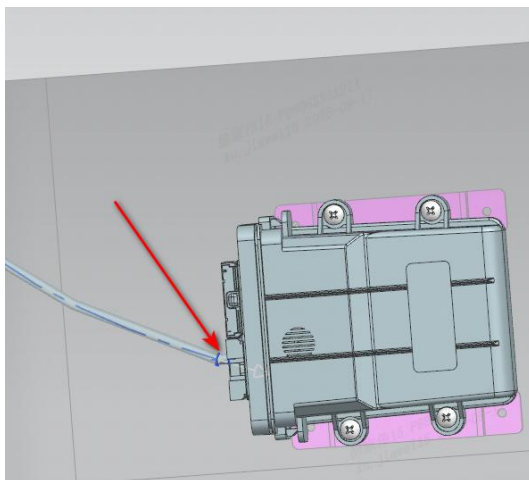

Figure 7.5

2.2 Alcohol Lock ECU harness and handset spiral harness mated in the location shown.

2 Alcohol Lock Parts Harness

/

/

/

/

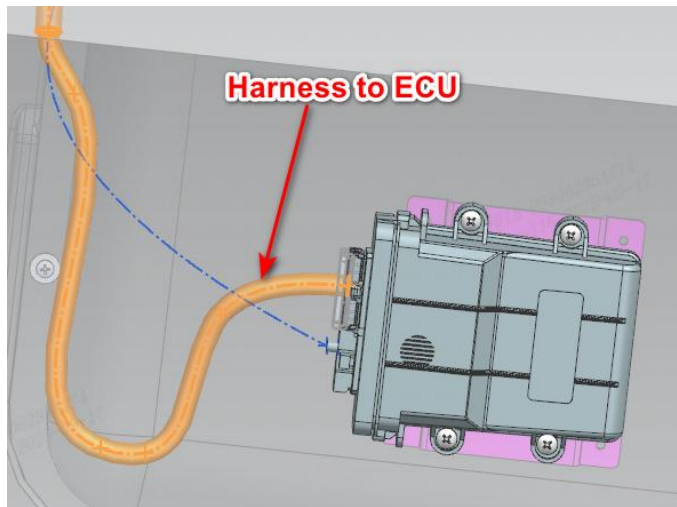

Figure 7.6

2.3 Connect product end connectors to Low Voltage Distribution Box Lead-in Harness Connectors, Installation is complete.